

Digital optical fiber sensor

OMRON

E3X-ZD series

NEW



[Slim • Smart • Simple]



realizing



The simplest E3X-ZD series

Easy Operation for Anyone

Simple Design
Easy pushbuttons
×
Extra-large display screen



The major features of E3X-ZD

Set without using the manual.



[Time-saving]

Independent teaching function button

Push the button twice to adjust both the teaching and sensitivity.

After fixing the optical fibers:

Press the “Teach” function button once in the presence of the test object and another time in the absence of the test object to set up the threshold and to adjust the maximum sensing for proper brightness. It saves the users’ time spent on making adjustment. The figure below is a comparison of the operation procedures between the new E3X-ZD and existing model.

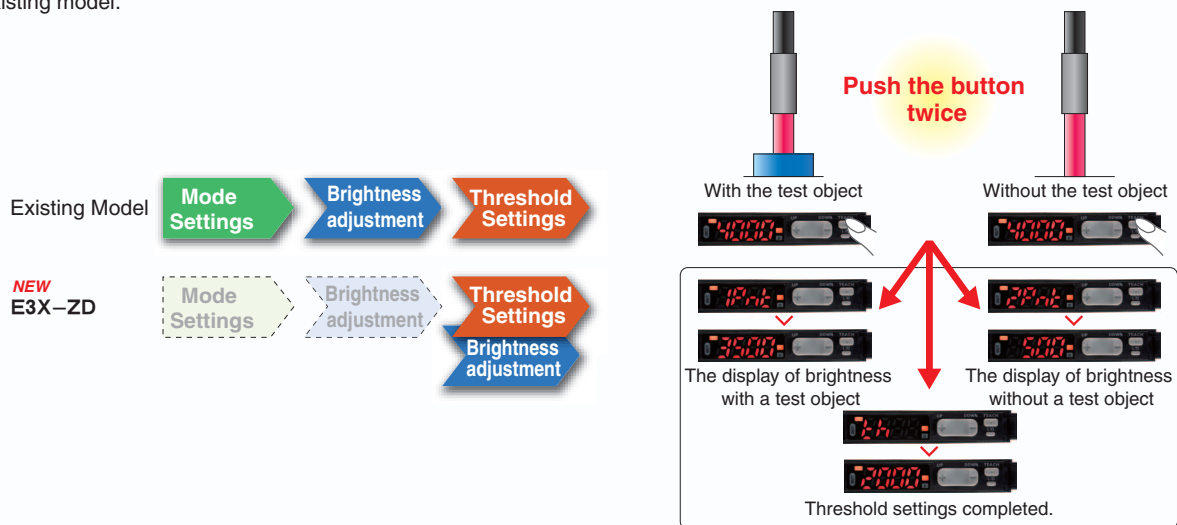

[Task-saving]

Extra-large set key

The large size set key makes threshold adjustment much easier.

The figure on the right is a comparison between the buttons of E3X-ZD, the new version, and of the old version.



[Trustful]



Large display screen + Status indicator

This newly installed operation mode indicator (L-ON /D-ON) and the teaching status display indicator allow you to learn about the status at a glance.



Types

Amplifier unit (main body)

Shapes	Connections	Model	
		NPN output	PNP output
	Pre-wired models	E3X-ZD11 2M	E3X-ZD41 2M
	Connector models*	E3X-ZD6	E3X-ZD8

* Suitable connectors: Please use the following simplified wiring connectors (each sold separately).

Simplified wiring connectors (each sold separately)

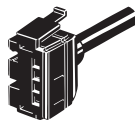
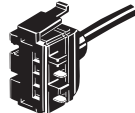
Types	Shapes	Cable length	Quantity of conductors	Model
Master connectors		2m	3-wire	E3X-CN11
Slave-connectors			1-wire	E3X-CN12

Up to 16 units can be connected

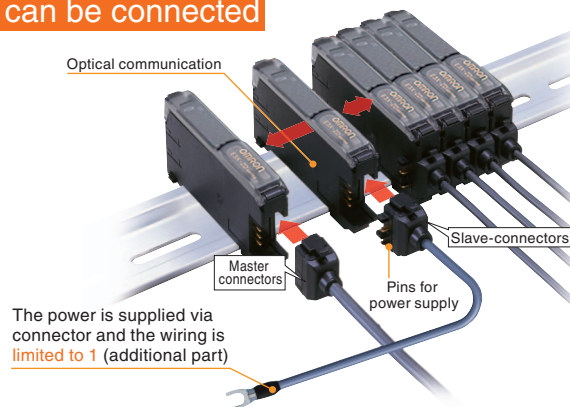

Note: It can be mixed and used with other series (e.g., E3X-DA).

Precaution for making order for connectors of different models (the main body and the connector are sold separately). Please review the following combinations when making the order:

Amplifier unit		Suitable connectors (each sold separately)	
NPN	PNP	Master connectors	Slave-connectors
E3X-ZD6	E3X-ZD8	E3X-CN11 (3-wire)	E3X-CN12 (1-wire)

<Example of 5 sets>

Amplifier unit (5 units)	+	Master connector (1 unit), Slave-connectors (4 units)
--------------------------	---	---

Accessories (each sold separately)

Metal fixing installation accessories

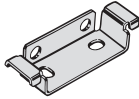
Shapes	Model	Quantity
	E39-L143	1

Rear pedestal

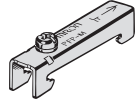
Shapes	Model	Quantity
	PFP-M	1

Rating / Performance

Amplifier unit

Item /Model	E3X-ZD□	
Light source (emitted wavelength)	Red AIGALNN LED (620nm)	
Power supply voltage	DC12~24V ±10% Ripple (P-P) 10% max.	
Power consumption (current consumption)	960mW max. (supply voltage 24V with current consumption 40mA max.)	
Control output	Open collector output (NPN or PNP) Load current 50mA max. (Residual voltage 1.5V max.) L-ON and D-ON pushbutton switch	
Response time	Action •Reset: 200 μ s maximum for each	
Sensitivity adjustment	Teaching (With or without workpiece/Automatic) or manual adjustment	
Protection circuit	Power reverse protect, output short-circuit protection, reverse output polarity protection	
Digital display	Light power/Threshold 0 ~ 9999	
Indicator (Orange)	L-ON/D-ON indicator, Teach mode indicator, Operation mode indicator	
Mutual interference prevention	Light parallel (5 sets)*	
Vibration resistance(destruction)	10 to 55Hz, 1.5mm double amplitude for 2h each in X, Y, and Z directions	
Shock resistance(destruction)	500m/s ² for 3 times each in X, Y, and Z directions	
Ambient illumination	Incandescent lamp: 10,000lx max., Sunlight: 20,000lx max.	
Ambient temperature	Operation: Group of 1 to 3 Amplifiers: -25 ~ +55°C (with no condensation) Group of 4 to 11 Amplifiers: -25 ~ +50°C (with no condensation) Group of 12 to 16 Amplifiers: -25 ~ +45°C (with no condensation) Storage: -30 ~ +70°C (with no condensation)	
Ambient humidity	Operation and storage: 35~85%RH(with no condensation)	
Insulation resistance	20M Ω minimum (DC500V)	
Dielectric strength	AC 1,000V 50/60Hz 1min	
Degree of protection	IEC60529 IP50 (with the protective cover)	
Weight (packaged state)	Pre-wired models: Approx. 100g, Simplified wiring plug-in models: Approx. 40g	
Materials	Case	Polybutylene phthalate (PBT)
	cover	Polycarbonate (PC)
Accessories	User Manual	

* Please place the amplifiers as close as possible to each other for the mutual interference function.

Simplified wiring connectors

Item /Model	E3X-CN11	E3X-CN12
Rated current	2.5A	
Rated voltage	50V	
Contact resistance	20M Ω max. (at DC20mV and 100mA max.) [Connected to the amplifier units and the connectors (wire resistance excluded)]	
Plugging (destruction)	50 times (connected to the amplifier units and the connectors)	
Materials	Housing	Polybutylene phthalate (PBT)
	Contact	Phosphor bronze/Nickel-cadmium alloy plating (PC)
Weight (packaged state)	Approx. 55g	Approx. 25g

Output circuit diagrams

Model		Operation mode	Timing chart	Status Selector	Output circuit
NPN Output	E3X-ZD11 E3X-ZD6	Light ON		L•ON (LIGHT ON)	
		Dark ON		D•ON (DARK ON)	
PNP Output	E3X-ZD41 E3X-ZD8	Light ON		L•ON (LIGHT ON)	
		Dark ON		D•ON (DARK ON)	

Dimensions

Amplifier unit

Pre-wired models

E3X-ZD11

E3X-ZD41

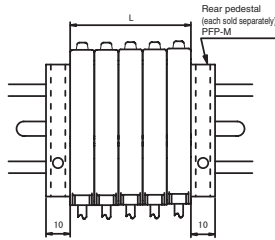

No. of additional unit	L(mm)
1	10
2	20
3	30
4	40
5	50
6	60
7	70
8	80
9	90
10	100

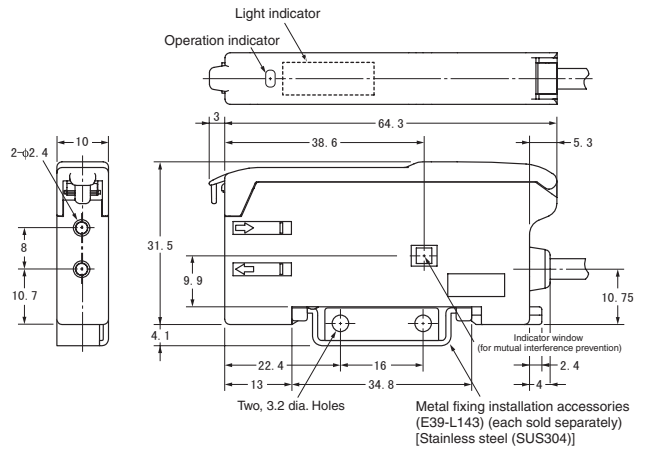

Connector models

E3X-ZD6

E3X-ZD8

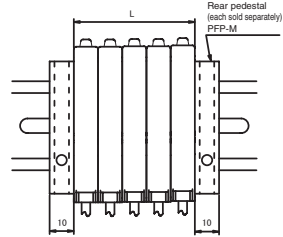

No. of additional unit	L(mm)
1	10
2	20
3	30
4	40
5	50
6	60
7	70
8	80
9	90
10	100

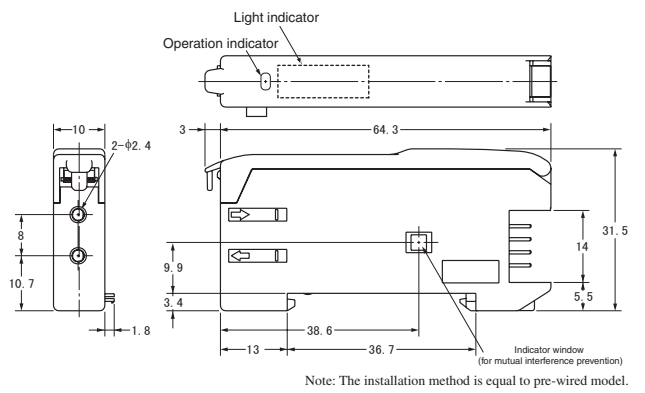

Simplified wiring connector units

Female connectors

E3X-CN11

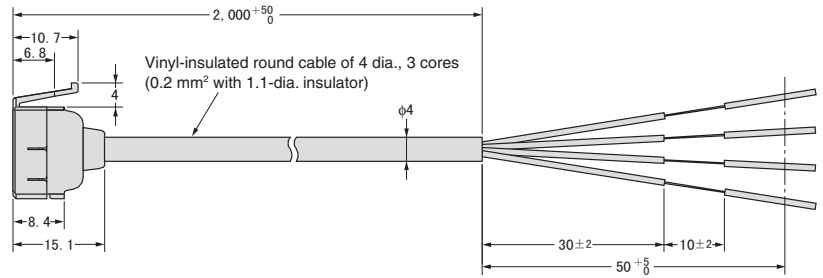
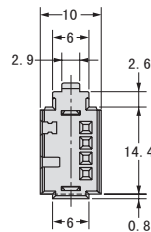
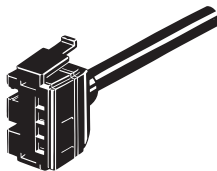

Sub-connectors



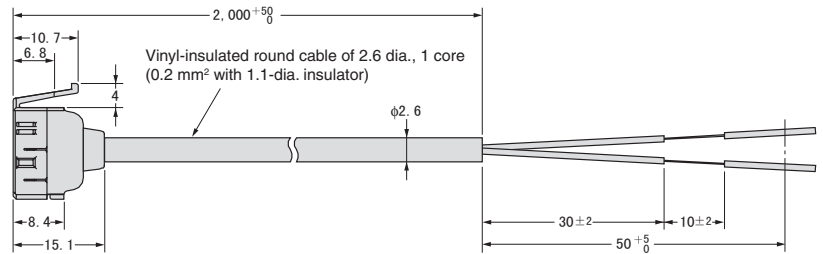
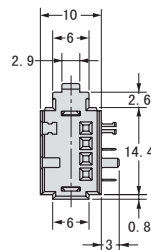
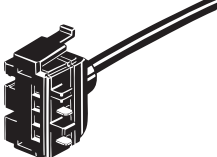





E3X-CN12

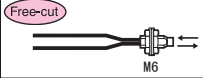
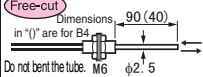

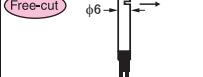

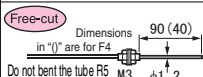
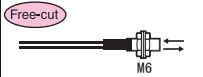
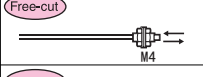
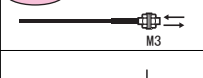

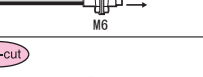
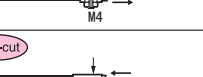
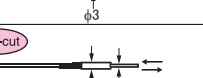

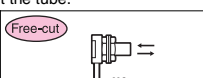
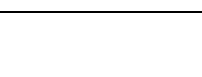

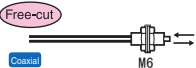

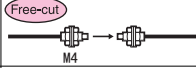
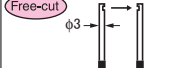
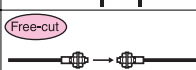

Optical fiber types

Reflective Through-beam

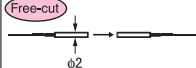
* Use amplifier unit E3X-ZD

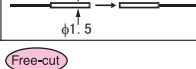
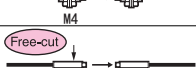
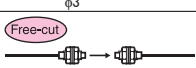
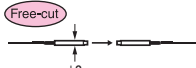
Types	Shapes(mm)*3	Sensing distance (mm)*1	Minimum sensing object (mm)*2	Bending radius (mm)	Feature	Model
Standards		150	(φ0.005)	R25	M6 screws	E32-DC200
		150			M6 screws with tubes	E32-DC200B E32-DC200B4
		120			3 dia. columns	E32-D12
		40			6 dia. columns (Side View)	E32-D14L
		36		R10	M3 screws (small)	E32-DC200E
		36			M3 screws (small) with tubes	E32-DC200F
Bent-resistant		90	(φ0.005)	B R4	M6 screws	E32-D11
		35			M4 screws (small)	E32-D21B
		15			M3 screws (small)	E32-D21
		15			1.5 dia. columns (small)	E32-D22B
Long distance / High performance		200	(φ0.005)	R25	M6 screws	E32-D11L
		50		R10	M4 screws	E32-D21L
		50			3 dia. columns	E32-D22L
Ultra-compact / With thin tube		10	(φ0.005)	R4	0.8 dia. tubes	E32-D33
		1.5			0.5 dia. tubes	E32-D331
Flexible (New standard)		90	(φ0.005)	R R1	M4 rectangular screws	E32-D11N

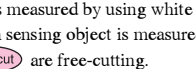
Types	Shapes(mm)*3	Sensing distance (mm)*1	Minimum sensing object (mm)*2	Bending radius (mm)	Feature	Model	
Coaxial / Small luminous spot	 Free-cut Coaxial M6	150	$\phi 0.005$	R25	M6 screws	E32-DC200	
	 Free-cut Coaxial M3	40			M3 screws (small)	E32-C31	
	 Free-cut Coaxial M3	13		R R4	M3 rectangular screws	E32-C31N	
	 Free-cut	6 ~ 15mm Spot dia $\phi 0.5 \sim 1$ mm		R25	Small luminous spot (variable)	E32-D32 + E39-F3A	
	 Free-cut	7mm Spot dia $\phi 0.5$ mm			Small luminous spot	E32-C31 + E39-F3A-5	
	 Free-cut	17mm Spot dia $\phi 0.5$ mm			Long distance / Small luminous spot	E32-C31 + E39-F3B	
	 Free-cut 4 dia. luminous spot	0 ~ 20mm Spot dia $\phi 4$ mm max.			Long distance / Parallel light	E32-C31 + E39-F3C	
Standards	 Free-cut M4	400	$\phi 1 (\phi 0.005)$	R25	M4 screws	E32-TC200	
	 Free-cut $\phi 3$	240			3 dia. columns (Side View)	E32-T14L	
	 Free-cut M3	360			M3 screws (small)	E32-TC200A	
	Dimensions for small model	 Free-cut M3	100	$\phi 0.5 (\phi 0.005)$	R10	M3 screws (small)	E32-TC200E
		 Free-cut $\phi 2$	100			2 dia. columns (small)	E32-T22
Bent-resistant	 Free-cut M4	360	$\phi 1 (\phi 0.005)$	B R4	M4 screws	E32-T11	
	 Free-cut M3	100	$\phi 0.5 (\phi 0.005)$		M3 screws (small)	E32-T21	
	 Free-cut $\phi 1.5$	100			1.5 dia. columns (small)	E32-T22B	
Long distance / High performance	 Free-cut M4	700	$\phi 1.4 (\phi 0.01)$	R25	M4 screws	E32-T11L	
	 Free-cut $\phi 3$				3 dia. columns	E32-T12L	
	 Free-cut M3	200	$\phi 0.9 (\phi 0.005)$	R10	M3 screws (small)	E32-T21L	
	 Free-cut $\phi 2$	200			2 dia. columns (small)	E32-T22L	
Flexible (New standard)	 Free-cut M4	280	$\phi 1 (\phi 0.005)$	R R1	M4 rectangular screws	E32-T11N	

*1. The sensing distance is measured by using white drawing paper.

*2. The value of minimum sensing object is measured when setting the sensing distance and sensitivity at the optimal state in the standard mode (typical).

*3. The models with (Free-cut) are free-cutting.

Note: Check our website for more detailed dimensions.

R Flexible **B** Bent-resistant

Correct usage

Precautions for Correct Use

Do not install the products at the following locations:

- In the place exposed to the direct sunlight.
- In the place where humidity is high and condensation may occur.
- In the place where corrosive gas exists.
- In the place where vibration or shock is directly transmitted to the product.

If the power lines and the photoelectric switch share the same wiring casing or wiring slot, product malfunction or damage can happen due to induction. In principle, please separate the wiring or use a shielded line. For extending the cable, please adopt a cable that is at least 0.3mm and limit the length to 100m or less.

After turning on the power, wait for at least 200ms before conducting the detection. If the power supply for the product and the electric load are separated, make sure to turn on the power of the product first.

Output pulses will be generated when turning off the power, so make sure that the power of the electric load or the load line is turned off first.

In order to prevent electric shock or short-circuited when using the connector type, please put a protector seal on the power terminals that are not connected (connector: provided with the E3X-CN series)

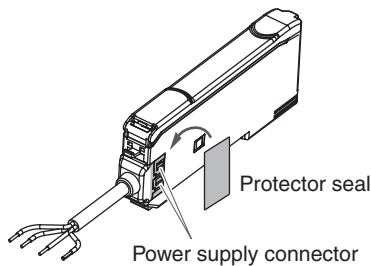

Make sure that the power supply is turned off before separating or adding amplifiers.

Do not perform product expansion or compression when the optical fibers are fixed at the amplifier units.

Make sure that the protection cover is in place when operating the product.

Do not use thinners, benzene, acetone, or kerosene for cleaning the product.

Settings

Amplifier unit

Mounting Units

Fit the track by inserting the claw of the side of the optional fibers unit insertion and then pressing the hooks, until it is locked in place.

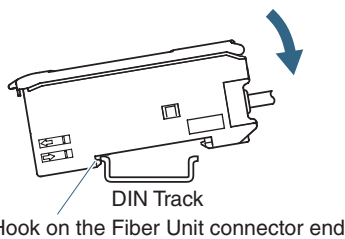

Note: Make sure that the insertion side of the optical fiber unit is mounted onto the track before carrying out the installation. Reverse installation will reduce the installation strength.

Removing Units

Press location 1 and then lift the insertion site of the optical fiber sensor toward location 2.

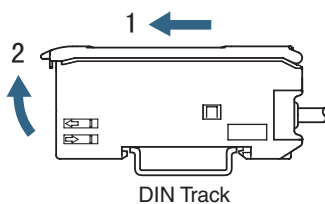

Joining Amplifier Units (for Units with Connectors)

Up to 16 Units can be joined.

1. Mount the amplifier unit onto the DIN track.
2. Slide the amplifier unit and then insert it into the connector until you hear a click.

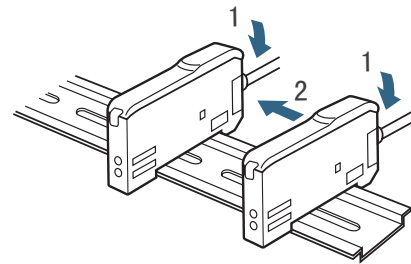

Note: For vibration may disconnect the connection. Please use the optional installation accessory (PFP-M) for securing. Please remove it in the reverse sequence. Make sure that the amplifier unit should be removed before DIN track is removed.

Note: 1. When the units are connected, different number of connection can be applied for different conditions. Please confirm the "rating / performance".
2. Always turn off the power before connecting or disconnecting.

Simplified wiring connector units

Mounting Units

- ① When connecting the female connector to the sub-connector of a single amplifier unit, please insert it in the connector until you hear a click.

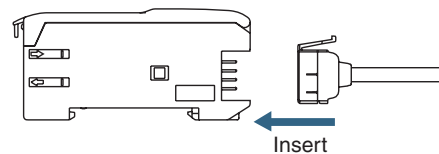

- ② Once the female connector and the sub-connector are well connected, please connect them to the amplifier unit.
- ③ Please put the accessory label on the non-connection side of the female- and the sub-connectors.

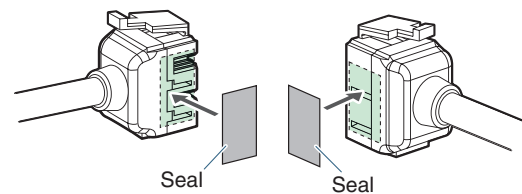

Note: Please put the Seal on the slot side.

Removing Units

- ① Slide the sub-connector.
- ② Press the paddle switch of the connector to completely separate the female connector from the sub-connector. (Do not unplug the connectors when they are connected.)

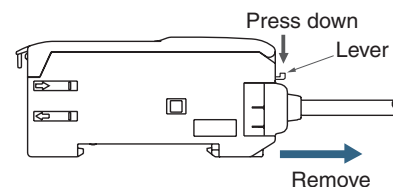

Optical fiber unit

Mounting Units

- ① Open the protection cover.
- ② Unlock the locking actuator.
- ③ Insert the optical fibers into the inlet of the amplifier unit and make sure it insert all the way.
- ④ Move the locking actuator back to the original position to secure the optical fibers.

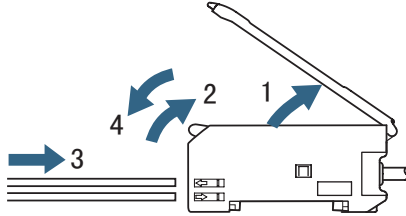

Note: About the insertion location of the optical fibers:
Outer diameter of the optical fibers $\phi 2.2\text{mm}$: The insertion position is presented as below.

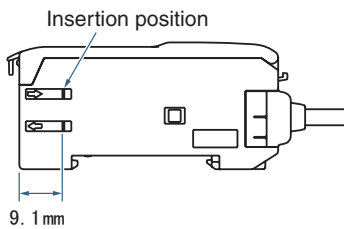

Note: A partial insertion may decrease the detecting distance.

Removing Units

Open the protection cover, unlock the locking toggle, and then pull out the optical fibers.

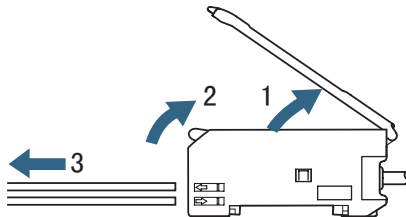

Note: To protect the characteristics of the optical fibers, please confirm whether the locking status is unlocked before pull out the optional fibers.

Secure the optical fibers

Tightening torques for installing the optical fiber units are shown as below.

(Screw fixed type)

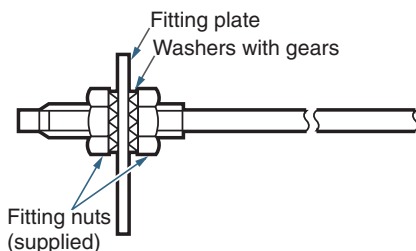

Optical fiber unit	Tightening torque
M4 screws type	0.78N · m Max.
M6 screws type	0.98N · m Max.

Note: Please use the tools matching the nuts.

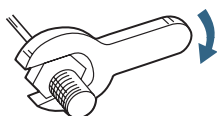

Optical fiber cutting

Insert the optical fibers into the hole of cutter. Adjust the length of it to meet your needs.

Pressing the cutter forcefully at one time.

Do not duplicated use the cutter hole or the shearing surface will be damaged and the detecting distance will be decreased.

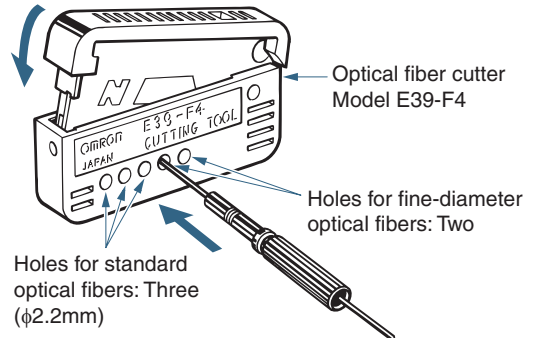

Others

About mutual interference function

Light from other sensors will affect the digital display value unstable. In this case, raise the sensitivity (by reducing the threshold) to stabilize the detecting.

About EEPROM writing errors

- ① If writing errors happen due to power supply interruption or static electricity at the teaching state, please restart the teaching.
- ② It takes a maximum of 9 seconds for inputting EEPROM. Do not operate the amplifier at this period.

About optical fibers communication

Make sure that the amplifier unit is inserted tightly to keep it from shaking or falling off prior to the operation.

About the operation environment

Dust on the optical fibers communication window can interfere with the communication. Please sweep off the dust before the operation.

About the recorded values as typical item

Record as typical item. The values of the minimum detecting object and the characteristic data are not always the guaranteed values from the rating / performance but are the values obtained from a randomly selected product of a randomly selected batch. Please use these values as references only.

About the protection cover

Make sure that the protection cover is mounted before operation.

A wide scope of applications

— Optical fiber amplifier lineup

High performance model

Pre-wired models
(Representing model E3X-DA21-S)

Connector models with simplified wiring
(Representing model E3X-DA7-S)

NEW



NEW



Color sensing models (Representing model E3X-DAC11-S)

NEW

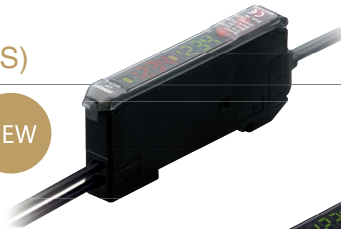

Dual channel models (Representing model E3X-MDA11)



Existing models (Representing model E3X-DA11-S)



For ordering our company's industrial automation products (hereinafter referred as the company's products) according to the product sample, the following conditions for warranty, exemption clause and intended product applications are applicable when there are no specific items referred in price quotation, contracts, specification manuals, etc.

1. Scope of Warranty: Under the company's warranty period, those faulty products that are part of the company's liability shall be repaired or replaced by the company free of charge. The users can ask for replacement or maintenance at the purchase location. Yet, this warranty does not apply to the following conditions:

a) Faults caused by operating the product under conditions/environments or adopting operating approaches that are not specified in the company's user manual of the product.

b) Faults not caused by the company.

c) Faults caused by performing modification or repair not approved by the company.

d) Faults caused by adopting product application methods not stated by the company.

e) Faults that cannot be predicted by available scientific methods upon the shipping of the products.

f) Faults due to natural disasters or disasters beyond the control of the company.

Meanwhile, the above-mentioned warranty only applies to the company's products themselves. Damages caused by the company's faulty products are not covered by the company's warranty.

2. Scope of Liability

(1). The company is not liable for special damages, indirect damages or other relevant damages caused by the company's products.

(2). For programmable devices, the company is not liable for faults or consequences if the programming task is carried out by persons who are not the staff of the company.

3. Scope and conditions for product application

(1). Clients have to check the product's application specifications, guidelines and rules before using the company's product in combination with other products. Furthermore, if the clients wish to integrate the company's product into their systems, facilities or equipments, they have to check the suitability of the incorporation. The company is not liable for the suitability of the company's products if the clients have not fulfilled the aforementioned requirements.

(2). Contact the sales of the company to verify the product's specification manual for the following conditions. Furthermore, please select products that are rated and have specific functional margin and consider all sorts of safety circuits to reduce the dangerous level to the minimum if faulty problems happen.

a) When the products are used outdoor, there are some potential chemical pollutions or electrical faults when the products are applied in environments or conditions that are not described in the product's user manual.

b) Atomic-control facilities, incineration facilities, railroad/aviation/vehicle facilities, medical facilities, entertaining facilities, safety facilities or other specific facilities are required according to the regulation of the administrative agencies or the standards of individual industry.

c) There are systems, facilities or equipments that may threaten the property or the life of people.

d) Check facilities that have to be highly reliable, such as the gas supply system, the water supply system, the power supply system and the 24-hr continuous operation system.

e) For others, please follow the description above to attain high safe product applications.

(3). When the clients are using the company's products at occasions that are closely related to the safety of people's life and property, please clearly check the dangerous level of the whole system. To apply the products safely, please adopt the specific design for redundancy, follow the company's suggested product application and purposes for the specific system, and implement the supporting power supply and wiring.

(4). The application examples mentioned in this manual are for references only. To actually adopt these examples in real situation, please verify that the functions of the devices or the facilities and the safety in advance.

(5). Please strictly follow the important notices and prohibited matters to avoid causing damages due to improper usage or other indirect reasons.

4. Change of specifications

The specifications and accessories of each product recorded in this manual are subject to modification if necessary. Please contact the staff at the sales locations immediately for updating the specifications.

5. Errors and negligence

Content of this manual has been verified in details. The company is not liable for errors or negligence in this manual in terms of the text, printing or proofreading.

6. Scope of services

Service expenses, such as technician dispatching expense, are not included in the company's product price. If such a service is required, please contact the sales representatives at the sales locations.

7. Applicable regions

The above-mentioned content is applicable for products traded at mainland China (Hong Kong, Macau and Taiwan excluded). For product traded and used at other areas or overseas, please contact the local sales representatives for purchase and usage information.

OMRON Corporation Industrial Automation Company
Tokyo, JAPAN

Contact: www.ia.omron.com

Regional Headquarters

OMRON EUROPE B.V.

Sensor Business Unit

Carl-Benz-Str. 4, D-71154 Nufringen, Germany
Tel: (49) 7032-811-0/Fax: (49) 7032-811-199

OMRON ASIA PACIFIC PTE. LTD.

No. 438A Alexandra Road # 05-05/08 (Lobby 2),
Alexandra Technopark,
Singapore 119967
Tel: (65) 6835-3011/Fax: (65) 6835-2711

OMRON ELECTRONICS LLC

One Commerce Drive Schaumburg,
IL 60173-5302 U.S.A.
Tel: (1) 847-843-7900/Fax: (1) 847-843-7787

OMRON (CHINA) CO., LTD.

Room 2211, Bank of China Tower,
200 Yin Cheng Zhong Road,
PuDong New Area, Shanghai, 200120, China
Tel: (86) 21-5037-2222/Fax: (86) 21-5037-2200

Authorized Distributor:

© OMRON Corporation 2009 All Rights Reserved.

In the interest of product improvement,
specifications are subject to change without notice.

Cat. No. E65Z-EN5-01

Printed in Japan
201109AK01